

**WARNING**  
警告

Always wear eye protective gear. 玩槍時，請始終戴着眼保護裝置。

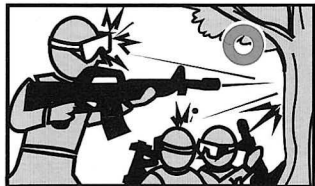

When shooting the air gun for a target or game, you and all participants must wear goggles or other eye protective gear, also paying attention to ricochets. (Pay sufficient attention also to third personnel other than participants.)

當使用汽槍射擊目標或遊戲時，你和所有的參與者都必須戴着防護眼鏡或其它眼保護裝置，同時要注意子彈的彈跳方向。（而且要特別注意不能射向遊戲者以外的第三者。）

You may be punished if you are shooting for a practical joke.  
如果用汽彈槍開惡意玩笑，可能會受到懲罰。

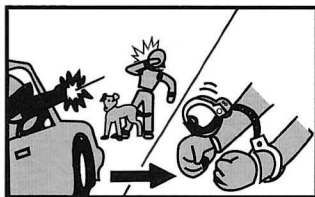

You may be punished if you damage public or personal properties or injure a person or animal even if you are shooting for a practical joke. Always observe manners and enjoy healthy sport shooting.

如果你損害公共的或私人的財產，或者傷害人或動物，即使你是在進行射擊實踐遊戲，你也會受到懲罰。請始終守規定，享受有益健康的運動射擊。

Never disassemble or modify the air gun. 避免拆除或修改該氣槍。

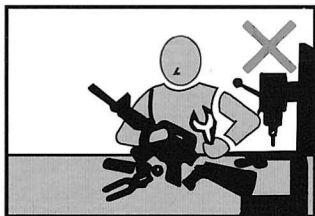

This air gun is manufactured under consideration of appropriate performance and operability. Disassembling or modifying the gun may generate danger or adversely affect the performance. So, avoid disassembling or modifying the air gun.

該汽槍是根據適當的性能和操作而製造的。拆除或改裝汽槍可能產生危險或者逆反操作。因此要避免拆除或改裝該汽槍。

Never look into the gun muzzle.  
禁止直接目視槍口。

Never shoot at any human or animal.  
禁止射擊人或動物。

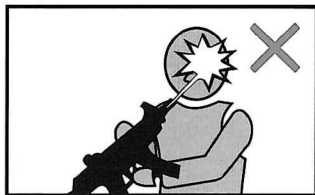

Do not look directly into the muzzle to avoid accidental discharge of BB.  
不要直接地看槍口，避免BB彈意外射擊。



Never aim or shoot a person or animal as the target. Always attach the protective plug to the muzzle.  
不可把人或動物當作目標瞄準或射擊。

- Make sure to operate an air gun after recognizing its features.
- We are not responsible for any accidents, events, injuries or repair costs arising from wrong operation and handling or by modification and disassembly of the gun.
- 請確保在了解其特徵之後再使用該汽槍。
- 對於任何由錯誤操作或改裝和拆卸汽槍所引起的意外事故，突發事件，受傷或修理費用，我們將不負有責任。

# AUTO ELECTRIC GUN

## SEMI & FULL AUTOMATIC AIRSOFT GUN

Users restricted to 18 years of age or older  
使用年齡對象18歲以上



AK74



AK74 U

Always read through this manual before operation.  
在操作之前必需讀熟這些說明書



### 警告 WARNING

|  |   |  |
|--|---|--|
|  | <p>18岁以上才能使用<br/>Only for 18 years of age or older</p>                            | <p>18岁以上年龄才能利用这支汽枪比赛使用<br/>Operation of this air gun for competition use is restricted to users of 18 years of age or older.</p>   |
|  | <p>注意受损伤<br/>Injury caution</p>   | <p>因为BB弹能达到50-60米范围，不小心的射击将可能导致眼睛受损伤或其它伤害。<br/>Since plastic BB bullets reach 50 to 60 meters, careless shooting may cause eye damage or other injuries.</p>   |
|  | <p>注意熟读警告指示手册<br/>Careful reading of Handling cautions and Instruction manual</p> | <p>在操作之前要细心读熟警告手册和指示手册操作汽枪时必须认识好警告指示<br/>Always read through this HANDLING CAUTIONS AND INSTRUCTION MANUAL carefully before operation. Operate the air gun with full recognition of warnings and cautions.</p> |

**THOROUGHLY UNDERSTAND THE WARNINGS AND CAUTIONS FOR SAFE OPERATION.**

詳細閱讀說明書中要注意的操作，才能安全的使用本產品。

**Read through this manual before shooting paying special attention for safe operation.**

在使用前，請仔細閱讀本說明書，以便安全的操作本產品。

**Always observe warnings and cautions strictly. Failing to do so may cause injury, accidents, or damage to the gun.**

要嚴格遵守本產品中的警告及注意事項。否則將造成傷害或是槍支的損害。

**1 CHARGING THE BATTERY (Battery and charger sold separately.)**

電池充電器（電池和充電器有單獨出售）

- Please use the special battery: 8.4V  
Do not use nonstandard battery or the other brand battery, or it will fall short of design demand.

使用槍支專用的電池。8.4伏小電池。  
請避免使用非標準或其他品牌的電池，否則將達不到設計要求。



**CAUTION** The SD and Mini Battery can not be used.  
△ 注意 不能使用SD和小類型的電池。

- Use the specified battery charger which is applicable to the above battery. The charger Exclusive Type ac Speed Charger.  
使用上述電池專用充電器。
- The battery's capacity power is increased with use of the Exclusive (battery) Discharger (Sold separately)  
使用專用的電池充電器會增加電池的能量。（有單獨銷售）
- Use the correct battery and charge according to respective instruction manuals. We will not be held responsible for any accidents or damage caused by wrongful operation or usage of non-specified batteries.

請根據使用手冊使用標準的電池和充電器。如果沒有按照說明書操作或者使用非專用的電池而引起的事務或傷害，我們將不負任何責任。

**2 THE NAME OF THE PARTS (For details, see the following pages.)**

各部分名稱（具體請參照下面）

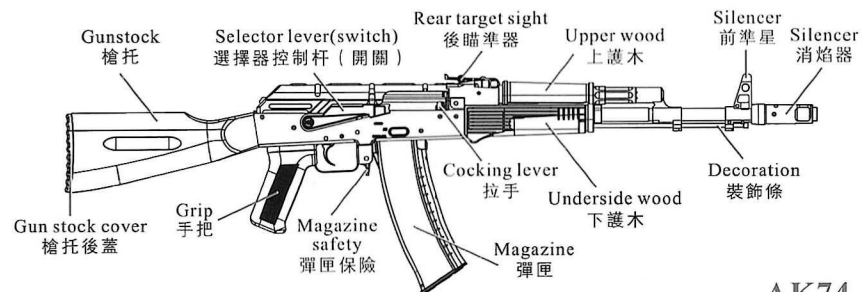

AK74

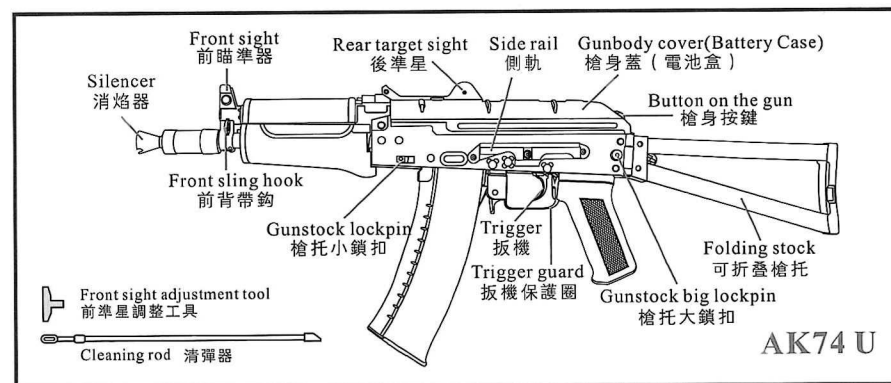

AK74 U

**3 SELECTOR LEVER AND SAFETY SETTING**

選擇控制杆和安全裝置

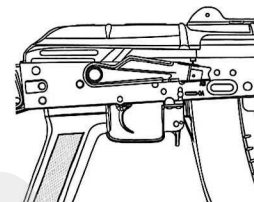

- To prevent malfunction of the switch do not change the selector lever from semi to full auto while pulling the trigger.  
為防止開關發生故障，在按扳機時，不要將選擇控制杆從半自動改到全自動。

**CAUTION** Set the selector lever correctly in position otherwise, malfunction may occur.  
△ 注意 將選擇控制杆設置在正確的位置，否則將會發生故障。

**① Safety setting (the trigger cannot be pulled.)**

安全裝置（不能按下扳機）

When you are not firing the gun or during storage always set the selector to the safe position.

當你射擊或在裝子彈時，請將選擇器設置在安全位置。

**② Fully automatic (automatic firing)**

全自動（連擊）

The gun will fire automatically while the trigger remains pulled.

按緊扳機，  
汽槍將自動射擊。

**③ Semi automatic**

半自動

The gun will fire one shot each time the trigger is pulled.

每按一次扳機，  
汽槍將發射一發子彈。

**4 SETTING THE BATTERY (Set the battery after charging)**

安裝電池（用充電器先把電池充滿）

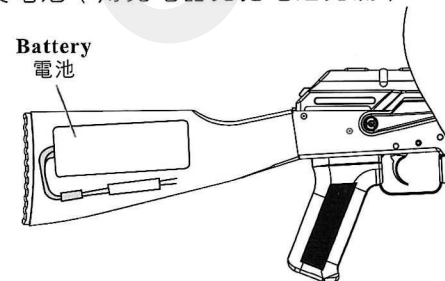

1 Remove the bull plate by pressing it downwards and pull out the connector.  
按下蓋板以將其取下并拔出連接器。

2 Insert the battery in the tail gunstock and connect the jack  
將電池裝入槍托裏并接上連接器。

3 Press down the fuse box and insert connectors and cords between the fuse box and battery. Bend cords in the S shape.  
壓入保險絲盒，然後在保險絲盒和電池之間插入連接器和電線將電線彎曲成S形。

4 When the battery and cords are set in positions, reinstall the butt plate as shown.  
當電池和電線正確安裝後，如圖所示重新裝上蓋板。

**AK74**

① Press the upper cover catch button and upper cover pop-up automatically  
按下槍身蓋後部的按鈕，槍身蓋將自動彈開

② Connect the battery to the cord that is accessible from the hole under the rear sight. Press in the battery with its protrusion facing to the left.  
將電池接在後端孔伸出的綫，電池突出部分朝向電池左邊并按下。

Battery Sectional View  
電池裝配示意圖

The protrusion must be on the left side.  
突出部分必須置于左邊

Connector nail  
接頭

③ Reinstall the receiver top in the reverse order of removal procedure in step(1). Align the lead edge of receiver top to the groove under the rear of receiver top, aligning to the groove shown below.  
按步驟1的卸槍身蓋程序的相反順序重新安裝槍身蓋，槍身蓋的邊和槽邊堆砌，按槍身蓋後邊。

When receiver top is set correctly, the catch button ejects out.  
當按鍵彈出時，表示槍身蓋安裝正確。

**AK74 U**

**5 SETTING THE MAGAZINE 安裝彈匣**

① Open the cover of the magazine  
打開彈匣蓋

② Insert 6mm BB bullets into the loader (500 bullets can be loaded)  
將6mm BB彈裝入彈匣 (可裝入500發BB彈)

③ Replace the magazine cover  
蓋上彈匣蓋

④ Move the gear with hand clockwise until it is fully wound, and the bullets will be sent up automatically. (It can send about 150 rounds automatically.)  
以順時針方向拔動牙輪，直到上滿鍵，子彈就會自動往上送。(能自動送彈約150發)

⑤ Set the magazine upward. Install the magazine as illustration.  
從上方安裝彈匣。可以按箭頭所示步驟安裝彈匣。

1. First set the front. 首先裝前方  
2. Press to the rear. 向後按  
3. Press the release lever towards the trigger to lock. 朝扳機方向按下并鎖定。

Magazine stopper relief rib. 彈匣自動裝置解除鈕  
Slide the rib in the arrow direction to remove remaining BB bullets. (Be careful since BB bullets may jump out.) 按箭頭方向移動按鈕取出剩餘BB子彈。(小心BB子彈可能會跳出)

CAUTION 注意  
The magazine is capable of containing 500 BB bullets. 彈匣可裝500發BB彈。

CAUTION 注意  
Always use the BB bullets for the air gun. We shall not be held responsible for any damage or accidents arising from the use of bullets supplied by other manufacturers. 這種氣槍祇能使用標準的6mmBB彈。如果使用其他供應提供的子彈而引起的損害和事故，我們將不負任何責任。

**6 MOVEABLE PARTS 可動的零件**

**REAR SIGHT ADJUSTMENTS 後瞄準器的調節**

Rear sight 後瞄準器  
Sight 瞄準器

Long distance 遠距離  
Short distance 近距離

Press 壓

Elevation(up/down) adjustment button 仰角(上/下)調節按鈕

① The AK74 series rear sight is a tangent type which is adjusted vertically according to distance to the target.  
AK74系列氣槍的後視屬於相對獨立的類型。它是根據目標的距離垂直方向調整的。

② Press the adjust button and slide it forward or backward to move the sight up or down. The larger the number, the longer the distance to the target.  
按下調整按鈕向前或向後滑動以調整視野，數字越大，距離目標就越遠。

Insert the front sight adjustment tool in the front sight and turn it for adjustment.  
將前準星調整工具插進前準星裏，然後轉動以作調整。

Counterclockwise: lower sight point  
順時針方向：降低瞄準點

Clockwise: higher sight point  
逆時針方向：提高瞄準點

Rear Sight:  
Turn to front: short distance  
Turn to Rear: Long distance  
後瞄準器的調整：  
往前翻轉：近距離瞄準  
往後翻轉：遠距離瞄準

CAUTION 注意  
Be careful so as not to loose the adjustment tool.  
注意不要鬆開調整工具。

**INSTALLATION OF THE ELIMINATE BLAZE IMPLEMENT**  
消焰器的安裝

AK74

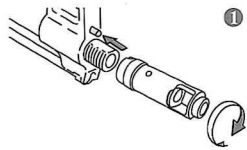

- ① While pressing the lock button.  
按下鎖定鍵
- ② Remove by turning the Eliminate blaze implement.  
旋轉消焰器

The eliminate blaze implement is fixed by counterclockwise as in the case of real gun 與真槍一樣，消焰器是用反向綫固定的。

Press the gun stock release button ①, move forward the gun stock.  
按下槍托鎖定鍵 ①，然後槍托就可以按箭頭方向折疊到前面。

**CAUTION**  
△注意

Be careful so that your skin and fingers do not get caught in the folding parts.

小心你的手指和皮膚不要被折疊的部分傷到。

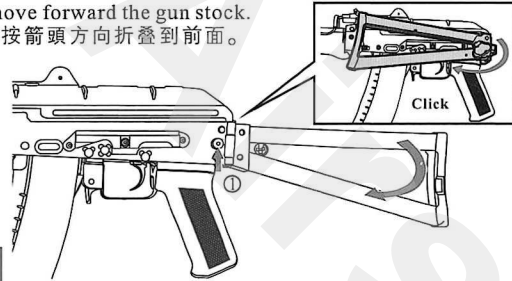

**INSTALLATION OF THE ELIMINATE BLAZE IMPLEMENT**  
消焰器的安裝

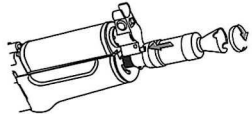

- ① While pressing the lock button.  
按下鎖定鍵
- ② Remove by turning the Eliminate blaze implement.  
旋轉消焰器

The eliminate blaze implement is fixed by counterclockwise as in the case of real gun. 與真槍一樣，消焰器是用反向綫固定的。

● **Setting the hand guard** 更換護木

Need to open the upper cover to take out the upper hand guard set. put the upper hand guard set first to close the upper receiver. 先打開槍身蓋，才能取出上護木，安裝時則要先裝上護木，再蓋上槍身蓋。

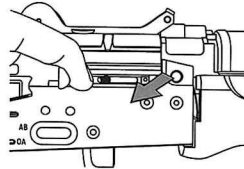
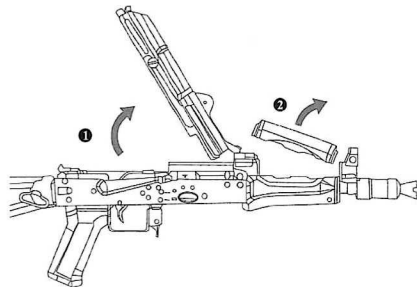

Variable hop-up adjustment lever  
可變化的跳動調整杠



The cocking lever can be moved.  
拉手是可移動的

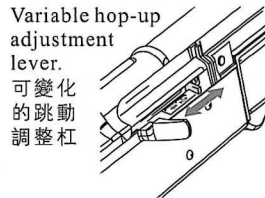

Variable hop-up adjustment lever.  
可變化的跳動調整杠

Pull the lower hand guard locking lever back, and push the fasten base ahead. Pull back the lower hand guard back and down to take off the lower hand guard.

將下護木固定杆往後扳，再將下護木前蓋往前推，再向前并往下便可以取下下護木。

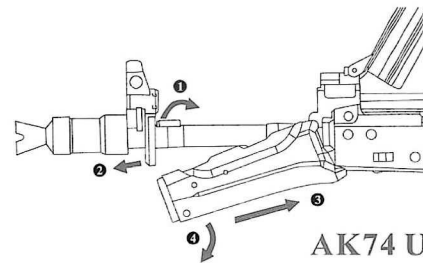

AK74 U

**7 FIRING (Confirm your shooting are a is safe before beginning firing.)**

射擊 (射擊前，確保射擊地方是安全的)

- ① Set the selector lever to Semi or Full Auto.  
把控制杆從設置在半自動或自動的位置
- ② Pull the trigger  
按住扳機



**CAUTION**  
△注意

A blank firing may occur ar triggering after the magazine, this is the normal operation of the gun. 當在你裝上子彈開始射擊時，可能會有空白的射擊，這是屬於槍的正常的情況。

**CAUTIONS ON MOTOR AND BATTERY** 發動機和電池使用注意事項

- Charge the battery if the firing cycle becomes slow.  
當射擊速度變慢，請充電。
- Give the air gun a rest for 5 to 10 minutes after firing about 500 rounds, in order to ensure long service lives of the motor and battery.  
為了確保發動機和電池的壽命，在射擊500輪後，給氣槍5-10分鐘的間歇。

**WHEN BULLETS ARE CLOGGED** 當子彈阻塞時，應採取的措施

- If bullets are clogged, remove them and apply a few drops of silicone oil in to the chamber from the magazine entrances shown or spray silicone oil for 0.5 or 1 sec, to obtain smooth continuous.  
假如子彈阻塞，把子彈取出來，為了以後順利的射擊，請從子彈匣的入口處往槍膛滴上或噴上幾滴潤滑油。

**AFTER OPERATION** 使用之後

- Remove the magazine and dry fire the gun in the semi auto mode directing the muzzle to a safe direction. (Otherwise the spring may be weakened). Set the selector to the Safe position.  
把子彈匣取出，在半自動的模式下，把槍對着安全的地方射擊。(否則，彈簧彈性可能會變弱) 把選擇器調到安全(safe)這一檔。
- Bullets may remain in the chamber even if the magazine contains no bullets (or if the magazine is not connected) (Two or three bullets may drop from the magazine, this is the normal opweator of the gun.)  
即使彈倉裏沒有子彈，(或彈倉被取出後)子彈也可能會留在槍膛裏。
- Always disconnect the battery and attach the protective cap whenever you do not operate the air gun.  
當你不使用氣槍時，必須斷開電池。

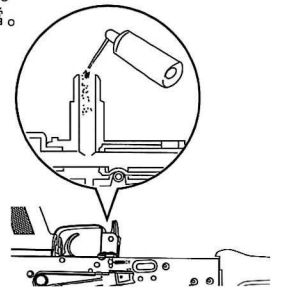

Always attach the protective cap during storage.



**CAUTION**  
△ 注意

- **There are possible cases that no firing occurs after pulling the trigger in the semi-auto mode. In this case, do not pull the trigger furiously. Fire 5 to 6 shots in the full auto mode and then return to the semi auto operation.**

在半自動的狀態下，有可能你按住扳機之後，子彈沒有射出來。遇到這種情況，不要猛烈地按住扳機，在全自動的狀態下，射擊5到6發，然後再調到半自動的狀態下嘗試。

- **Smell may be generated from motor for a while when a new air gun is operated. This is the normal operation of the gun.**

剛開始使用新氣槍時候，可能會有一股味道。這股味道是電機運轉時產生的，這種情況屬於正常現象。

- **The hopping up operation may be unstable for 200 to 300 rounds after using silicone oil, this is the normal operation of the gun.**

使用潤滑油之後，槍支的前200到300發可能不太穩定，這種情況屬於正常現象。

**§ VARIABLE HOP UP SYSTEM**  
可變化的Hop Up系統

By producing a back-spin to the BB bullets, this system allows for straighter and longer distance shooting than normal air gun. Unlike the fixed type, the variable hop up system permits one-touch adjustments using the dial and lever, making it an ideal hop up system.

通過使子彈逆轉，可以使射擊比一般的氣槍射得更直和更遠。不像其他的固定類型的氣槍一樣，可變化的Hop Up系統可以使用轉盤和調節杆來進行調整。

- ▶ **Adjustment Procedure (Adjust by carry out trial firing)**  
調節程序（通過試射擊來進行調節）

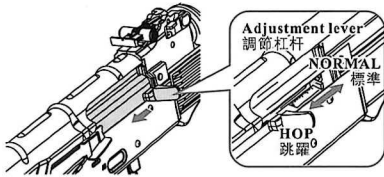

- Gradually turn the adjustment dial towards Hop to give hop up to bullets. (The best setting is where bullets fly horizontally.)

把調整鍵慢慢移向跳躍方向。  
(最佳設置為子彈水平方向射出)

- Turning excessively adversely affects the trajectory. So stop turning the hop adjustment lever when bullets fly horizontally.

向相反的方向用力的扭轉可能會影響到彈軌。因此，如果子彈能夠水平射出，就停止扭轉調節杆。

- The best position is where the bullets fly horizontally, and the longest flying distance is obtained. 最佳的位置是子彈水平方向射出，此位置使子彈達到最遠射程。

Too much hop-up (return the lever towards NORMAL)  
過度上旋 (將調節杆杆撥回正常位置)

Best position  
最佳位置

Not enough hop-up (return the lever towards NORMAL)  
上旋不到位 (將調節杆杆撥回正常位置)

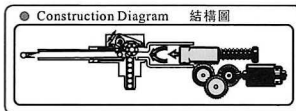
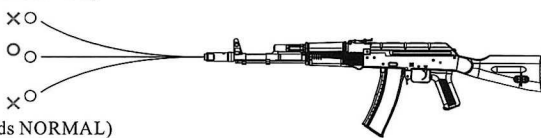

**OPERATIONAL CAUTION**  
(strictly observe the following caution)  
操作注意事項：(要注意以下的事項)

- Moving the lever too much towards HOP causes bullets to clog. Firing the gun with clogged bullets damages the piston and gears. 調節杆過度調向跳躍方向會導致子彈堵塞，子彈堵塞的情況下射擊會導致活塞和齒輪的損壞。
- If bullet clogging occurs, immediately stop firing the gun, return the hop lever to the Normal position and remove clogged bullets using the cleaning rod. 如果子彈堵塞，請立即停止，把跳躍杆調至正常位置，用清彈器取出堵塞子彈。
- Make sure to return the hop adjustment lever to the Normal position when removing clogged bullets or cleaning. (Otherwise, the chamber packing is damaged.) 在取出堵塞子彈時或進行清潔時，要把HOP調節杆調到正常的位置(Normal)(否則可能會損害槍膛)
- Never use used or dirty bullets. (Otherwise, the chamber becomes dirty, resulting in unstable hopping up.) 不要重複使用子彈或使用臟子彈。(否則彈膛會變臟，從而導致跳躍的不穩定)
- When about 10000 rounds are fired, spray silicone oil into the chamber for 0.5 to 1 sec. (See 11 on page 8. The hopping up operation may be unstable for 200 to 300 rounds after spraying the silicone oil, this is the normal operation of the gun.) 射擊大約10000粒子彈，用硅油噴彈膛0.5-1秒。(在噴硅油後，200-300輪射擊的跳躍操作會不穩定，這種情況屬於正常現象。)
- We will not be held responsible for any damage or accidents arising from wrongful operation, disassembly and modification of the gun. Any costs for repair of such damage shall be paid by the user. 由于錯誤操作，重組裝或改裝氣槍所引起的損壞或意外，我們一律不予負責，由此產生的維修費用由用戶自行承擔。

**WHEN HOPPING UP IS IMPROPER**  
跳躍不正常現象

| SYMPTOM 癥狀   | CAUSE 原因  | ACTION 方法  |
|--|---|--|
| <b>Bullets flying upwards.</b><br>子彈向上飛  | Too much hop setting (hop)設置太大                            | Gradually return adjustment lever towards Normal.<br>把調節杆逐漸地調到正常狀態。                                    |
| <b>Short flying distance of bullets (less hopping up effect).</b><br>子彈射程太短 (短于跳躍應有效果) | Too much hop setting (hop)設置太大                            | Gradually return adjustment lever towards Normal.<br>把調節杆逐漸地調到正常狀態。                                    |
|  | Hop packing contaminated by oil or dirt.<br>Hop包裝被油迹或污垢沾污 | Fire bullets equivalent to 4 or 5 magazines or clean the chamber using cleaning rod.<br>用(槍支的)清彈器清潔槍膛。 |
| <b>Cannot adjust</b><br>不能調節   | Worn or damaged hop packing<br>Hop包裝太舊或被損壞                | Purchase the replacement part at your dealer or from Marui and replace it.<br>向經銷商或我們購買所需配件，更換hop裝置。   |
|  | Damaged adjustment lever or other parts<br>調節杆或其他部件損壞     | Purchase the replacement part at your dealer and replace it.<br>向經銷商購買所需配件，更換hop裝置。                    |
| <b>Frequent bullets clogging</b><br>子彈經常阻塞   | Too much hop setting (hop)設置太大                            | Gradually return adjustment lever towards Normal.<br>把調節杆逐漸地調到正常狀態。                                    |
|  | Improper or too large sized BB bullets<br>BB彈不合適或太大了      | Use the BB bullets for Electric Gun.<br>使用標準BB彈。   |
|  | Dirty hop packing<br>Hop包裝弄臟                              | Clean using the cleaning rod or consult your dealer for repair.<br>用(槍支的)清彈器清潔或者向經銷商諮詢維修。              |

**CAUTION**

- If the hop-up is adjusted excessively causing clogging of bullets, immediately stop operating the gun. Return the lever to Normal, fire 2 or 3 shots and readjust.  
假如hop-up過分地調整可能會導致子彈的阻塞，遇到這種情況，立刻停止使用，把調節杆調至正常射擊(Normal)狀態下，射擊2到3發，然後重新調整。
- Since a precision tight barrel is used, use of dirty bullets or those with burrs causes clogging of bullets and possible fatal damage to the mechanical box and system.  
由于槍管非常精密，如果使用臟的子彈可能會導致子彈阻塞和很致命的損壞槍支。

**WARNING**

- Never hold the gun side ways as the BB bullets will curve tight or left. This is due to the HOP-UP system.  
不要從側面握住槍支進行射擊，因為BB子彈射出時可能會偏左或者偏右。

**9 MAINTENANCE 保養****1. Fuse Replacement Procedure 更換保險管**

Open the gunbody cover according to the method in page 3 4-1 to replace the broken safe cube.

按P3 4-1方法打開槍身蓋，然後便可更換已燒壞的保險管

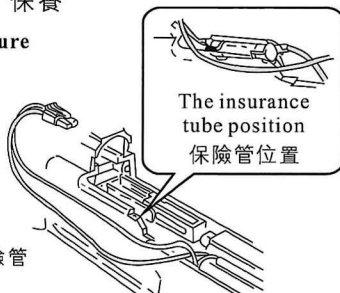

**Glass tube fuse 保險管**  
You can buy it at a near-by electric shop or gas station. 你可以在附近的五金店或電器店買到它。  
25A Fuse common for electric gun series. 常用於電動槍系列的25A保險管。



AK74 U

## AK74

The fuse box comes out when the connectors are pulled out of the stock.  
當連接器從槍托裏被拉出來時，也把保險絲盒拉出來。



Fuse box (when fuse is replaced, push into the stock all the way)  
保險絲盒 (當更換好保險絲後，直接把它推進槍托裏)

**Glass tube fuse 保險管**  
You can buy it at a near-by electric shop or gas station. 你可以在附近的五金店或電器店買到它。  
25A Fuse common for electric gun series. 常用於電動槍系列的25A保險管。

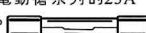
**2. Remove the obstruct bullets 拆卸堵塞子彈**

- ① Insert the cleaning rod into the bore. 沿槍管的內邊緣插入清彈器。
- ② Be careful so that the angled part of the cleaning rod faces down, and remove clogged bullets. 確保清彈器的角部分向下，并清楚堵塞子彈。

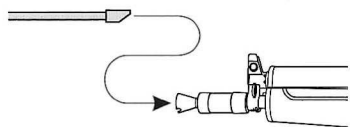

確保清彈器的角部分向下，并清楚堵塞子彈。

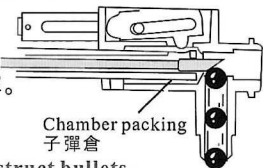

Chamber packing 子彈倉

The ornamental can not be used for cleaning the obstruct bullets.  
附在氣槍上的裝飾條模型不能用于清除堵塞子彈。

Make sure to insert the cleaning rod AFTER returning the hop up lever to the Normal position. (Hop-OFF)

確保跳躍調整杆回復到正常位置才能插入清彈器。

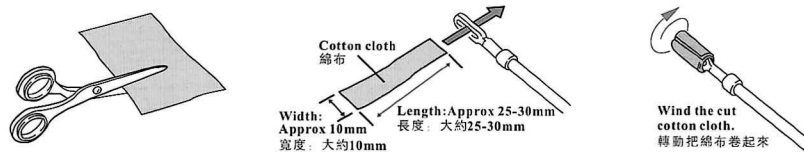
**CAUTION****3. Maintenance When Bullet Speed Become Low 當子彈速度變慢時怎樣維修**

Cut the cotton to the size shown. Adjust the length accordingly so that it can be inserted smoothly into the barrel.

將棉布剪成如圖所示才大小。適當地調整長度，以便於將其順利地插進槍管裏。

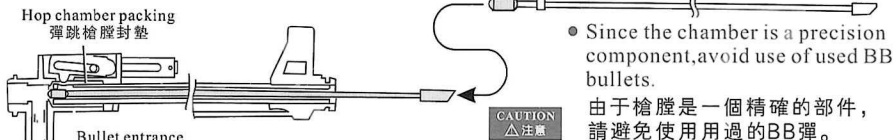
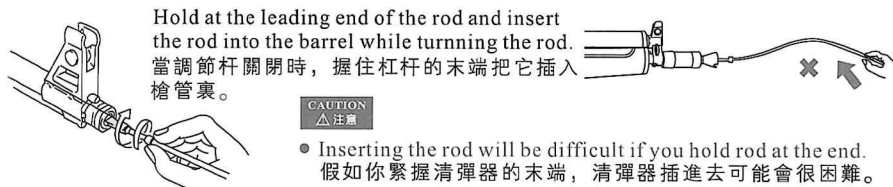

Apply a few drops of silicone or Teflon oil.  
滴幾滴硅樹脂或特氣輪油

Always carry out maintenance AFTER returning the hop up lever to the Normal position. (Hop-OFF)  
在將上旋杆撥回正常位置後，才能進行維修保養。

- ① Drop a few drops of silicone oil or Teflon oil from the bullet entrance, insert BB bullets into the magazine and fire bullets equivalent to 1 or 2 magazine.  
從子彈的入口處滴幾滴潤滑油。把BB子彈裝進彈倉，射擊1或2次。
- ② To complete the cleaning, use the cleaning rod (with cotton) as shown below, to remove excess oil.  
使用槍支清彈器按照以下說明除去多餘的潤滑油。

**4. FINE ADJUSTMENT OF GEAR ENGAGEMENT 齒輪啮合的微調**

Remove the screw from the grip bottom.  
在把手底部擰開螺絲。

M3 hexagon wrench  
M3六邊形扳手

Insert M3 hexagon wrench into the screw hole to adjust.

將M3六邊形扳手插入螺絲孔裏調整。



Only when the motor noise becomes high after operations for a long period of time, conduct the fine adjustment as shown.

若使用時間過長，電機發出很大的噪音時，請按如圖所示對電機進行微調。

Hold the grip during adjustment. Otherwise, the main body will drop since the grip set screw is removed.  
在調整時要握緊把手。否則，主體會因為固定把手的螺絲被取下來了而掉出來。

- It is recommended to lock the adjustment screw by a screw locking agent or instantaneous adhesive after adjustment of the motor position is complete.  
建議你在馬達位置調整完成後，使用螺絲釘固定器或瞬間黏合劑固定調整螺絲釘。
- Normally, do not attempt to adjust. 通常不要隨便調整。
- Be careful as not to overly tighten the screw as it will damage the gun.  
注意不要過度擰緊螺絲釘以免損壞氣槍。

**10 TROUBLE CLINIC(TROUBLE SHOOTING)**

故障診斷 ( 維修之前請確認是否發生故障 )

| SYMPTOM 癥狀  | CAUSE 原因  | ACTION 方法   |
|---|---|---|
| <b>No operation at all</b><br>無法操作  | Select or is set to safety.<br>選擇 ( 器 ) 杆調在安全這一檔 ( Safety )   | Set the selector lever to Semi or Full Auto 把選擇 ( 器 ) 杆調在半自動或全自動檔   |
|   | Battery is not charged.<br>電池沒有充電   | Charge the battery<br>給電池充電   |
|   | Battery connector is disconnected.<br>電池連接器被斷開  | Connect the connector<br>連接連接器  |
|   | The ⊕ and ⊖ or battery connector is revers.<br>電池的正負極連接器倒置  | Connect the connector correctly (check the fuse)<br>正確連接連接器 ( 檢查保險絲 )   |
|   | Fuse is blown out<br>保險絲爆裂  | Relace the fuse(See page )<br>重新換上保險絲 ( 見頁 )  |
|   | Expired motor life(50.000 to 60.000 rounds) or poor electrical connection.<br>50.000到60.000發時,馬達壽命可能耗盡或電線連接老化 | Replace the motor(purchasing from your dealer or us)or check and repair the contacts<br>換新的電機 ( 可向經銷商或我們購買 ), 或者仔細檢查和修理電線接觸點      |
| <b>Although motor is removing, bullets jump out.</b><br>電機沒有發生故障,但子彈無法正常發射。     | Bullets are clogged in the magazine<br>子彈阻塞在彈倉裏   | Insert the charging rod into the magazine and move up and down a few times to remove clogged bullets<br>用裝載杆插進彈倉裏,上下移動幾次,把阻塞的子彈移出 |
|   | Bullets are clogged in the chamber<br>子彈阻塞在 ( 槍 ) 膛裏  | Remove clogged bullets using the cheaning rod<br>用 ( 槍支的 ) 清彈器把阻塞的子彈取出  |
|   | Faulty gear<br>齒輪壞了   | Purchase the replacement gear from your dealer and repair<br>向經銷商購買新的齒輪後進行維修  |
| <b>Impossible full-auto operation.</b><br>(Automatic firing)<br>不能連發 ( 子彈無法射出 ) | Insufficient battery power<br>電池電量不足  | Charge the battery<br>給電池充電   |
|   | Faulty bullet feed of magazine<br>彈倉裏的子彈裝錯  | Repair clogging the magazine<br>清理彈倉裏的堵塞物   |
| <b>Impossible semi-auto operation.(Single shot)</b><br>不能單發                     | Poor electrical connection<br>電線連接不好  | Consult your dealer or us for overhaul maintenance or repair<br>向經銷商諮詢如何維修  |
|   | Deviation in gear timing<br>齒輪調配偏離  | Set to semi auto firing 5 to 6 rounds in full auto 在全自動這一檔射擊5到6次後調到半自動檔   |

**Use of poor quality BB bullets will cause problems.Never disassemble or modify the gun**  
如使用低質量的BB彈將出現問題。不要拆卸或修改槍支。

| SYMPTOM 癥狀   | CAUSE 原因   | ACTION 方法  |
|--|--|--|
| <b>Impossible semi-auto operation.(Single out)</b><br>不能半自動操作  | Insufficient battery power.<br>電池電量不足  | Charge the battery<br>給電池充電  |
| <b>Automatic firing become shorter.</b><br>連發射擊變慢              | Insufficient battery power.<br>電池電量不足  | Charge the battery<br>給電池充電  |
| <b>Shooting distance become shorter</b><br>子彈射程變短              | Worn or damaged chamber packing<br>( 槍 ) 膛材料太舊或壞了  | Consult your dealer or us for overhaul maintenance or repair. replace the chamber packing. piston packing(o-ring)and piston assembly.<br>向經銷商諮詢如何維修。重新換上槍膛材料, 活塞材料 ( O形圈 ) 和活塞組裝件。 |
|  | Worn or damaged chamber packing.(O-ring)<br>槍膛材料 ( O形圈 ) 太舊或壞了   |  |
|  | Deteriorated piston spring.<br>活塞彈簧損壞  |  |
|  | Faulty BB bullets.<br>(Too small or heavy)<br>BB子彈不合格 ( 太小或太重 )  | Use the genuine BB bullet<br>使用質量合格的BB彈  |
| <b>Too loud operating noise</b><br>噪音太大                        | Faulty gear.<br>齒輪壞了   | Purchase the replacement gear from your dealer and repair<br>向經銷商購買新的齒輪後進行維修   |
|  | Gear problem caused by too many blank firing or worn or damaged gear.<br>太多的空白射擊導致齒輪出現問題或者齒輪老化或損壞。   | Consult your dealer or us for overhaul maintenance,part replacement(gear etc)or repaie<br>向經銷商諮詢如何維修, 零件替換 ( 齒輪等 )   |
|  | Gear problem caused by too many blank firing<br>太多的空白射擊導致齒輪出現問題  |  |
| <b>Bullets being follen out from barrel end.</b><br>子彈從槍管頭彈出   | Worn or damaged chamber packing<br>( 槍 ) 膛材料太舊或壞了  | Turn the hop adjustment lever toward HOP<br>把調節杆調到HOP位置  |
|  | No hop setting<br>沒有設置HOP  |  |
|  | Faulty BB bullets.<br>(Too small)<br>BB子彈不合格 ( 太小 )  | Use the genuine BB bullet<br>使用質量合格的BB彈  |
| <b>Being wet or drop into water.(rain)</b><br>槍支弄濕或掉進水裏 ( 雨淋 ) | Stop operation immediately,disconnect the battery,wipe off water from water from inside themain body and the battery,and after complete dry,carry out trial firing,if no operation or malfunction is detected,consult your dealer or us for repair.<br>立刻停止使用, 斷開電池, 把電池和槍支內部的主要部分擦幹, 等槍支完全幹了之後, 再嘗試射擊。假如無法使用或者發現故障。向經銷商或我們諮詢如何維修。 |  |

AK74

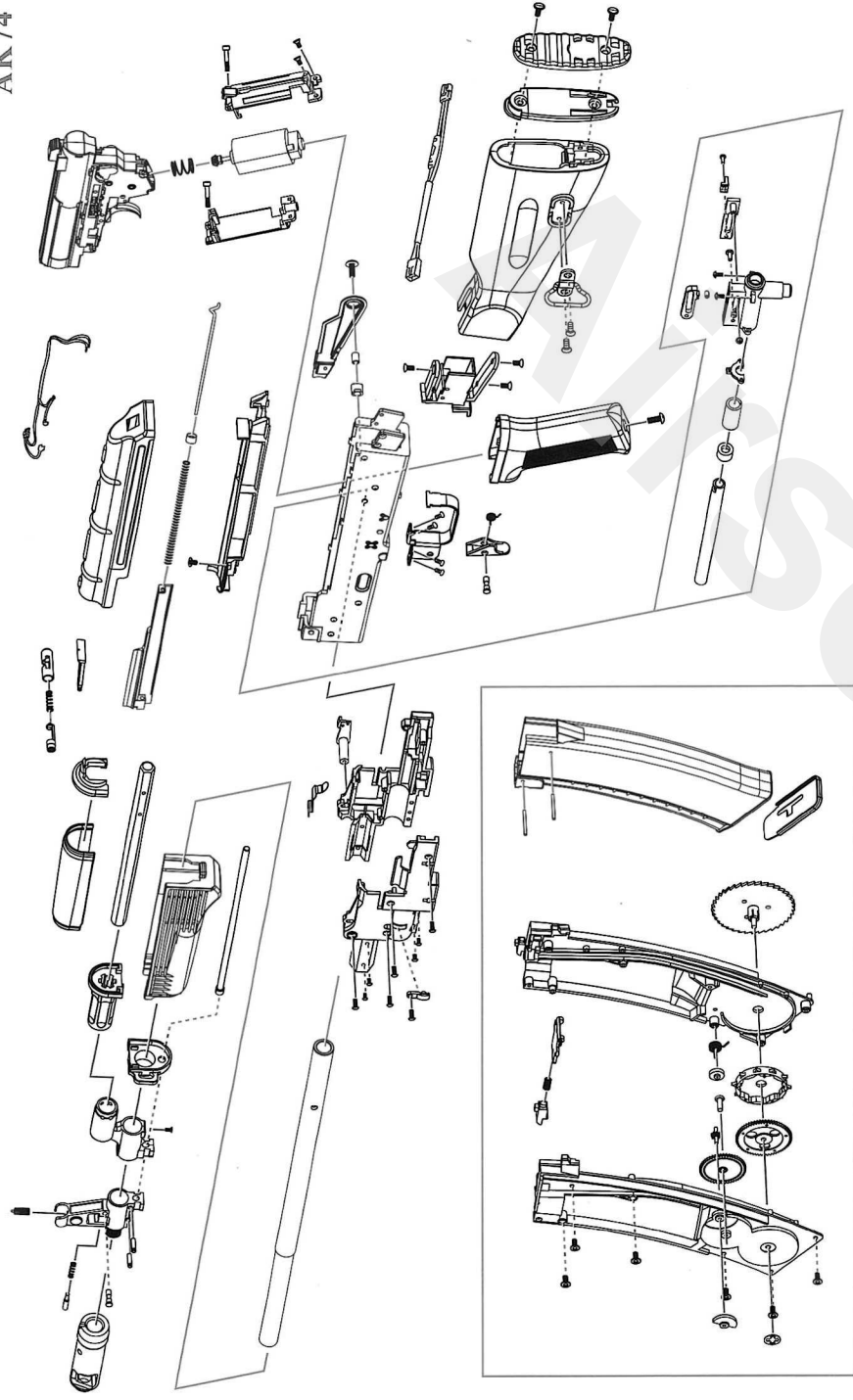

-13-

AK74 U

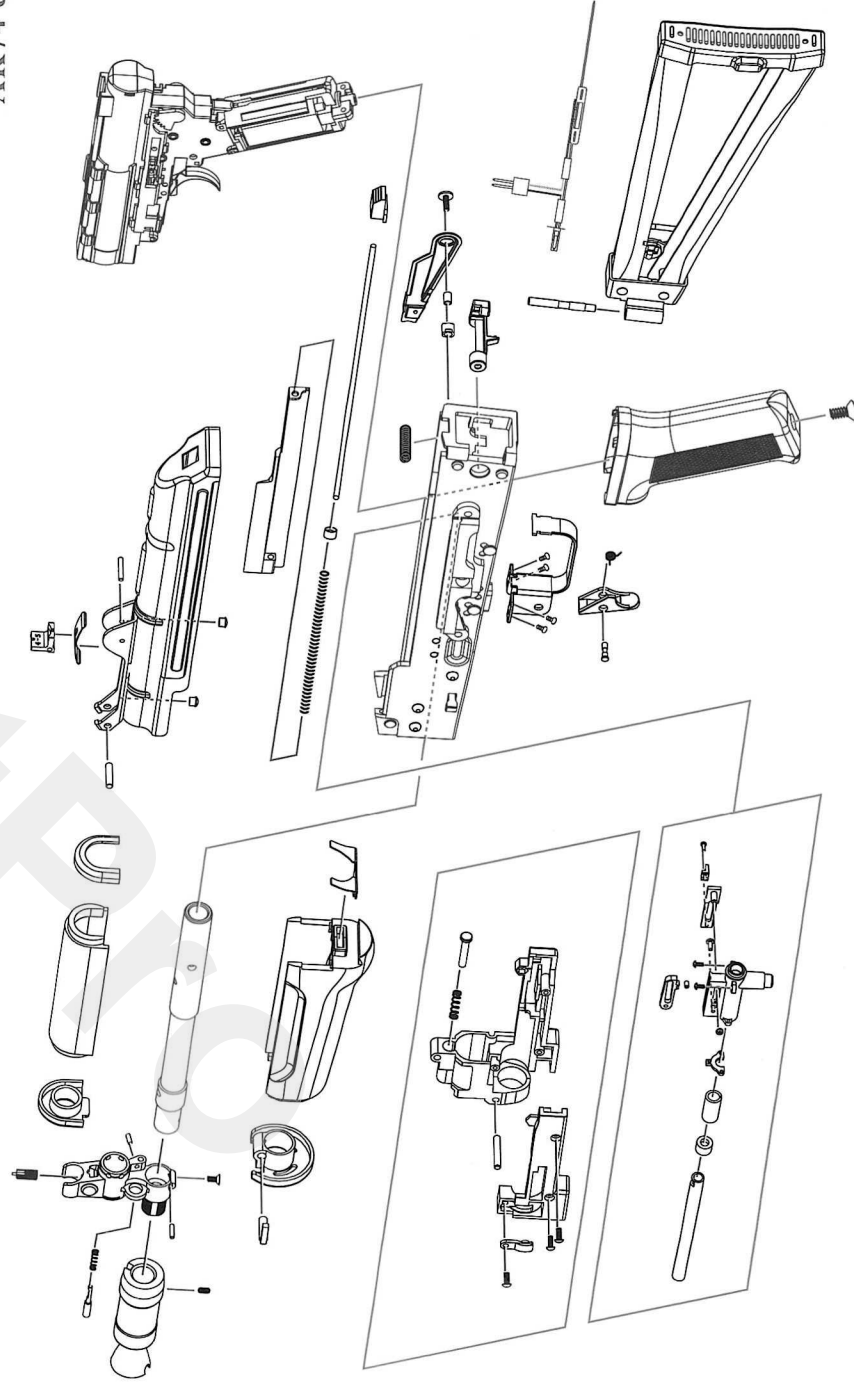

-14-